

Model L-1C Quick Setup Instructions

WARNING: Electrical and plumbing connections need to be made by a licensed service person and comply with all Federal, State and Local Health, Electrical, Plumbing and Safety codes.

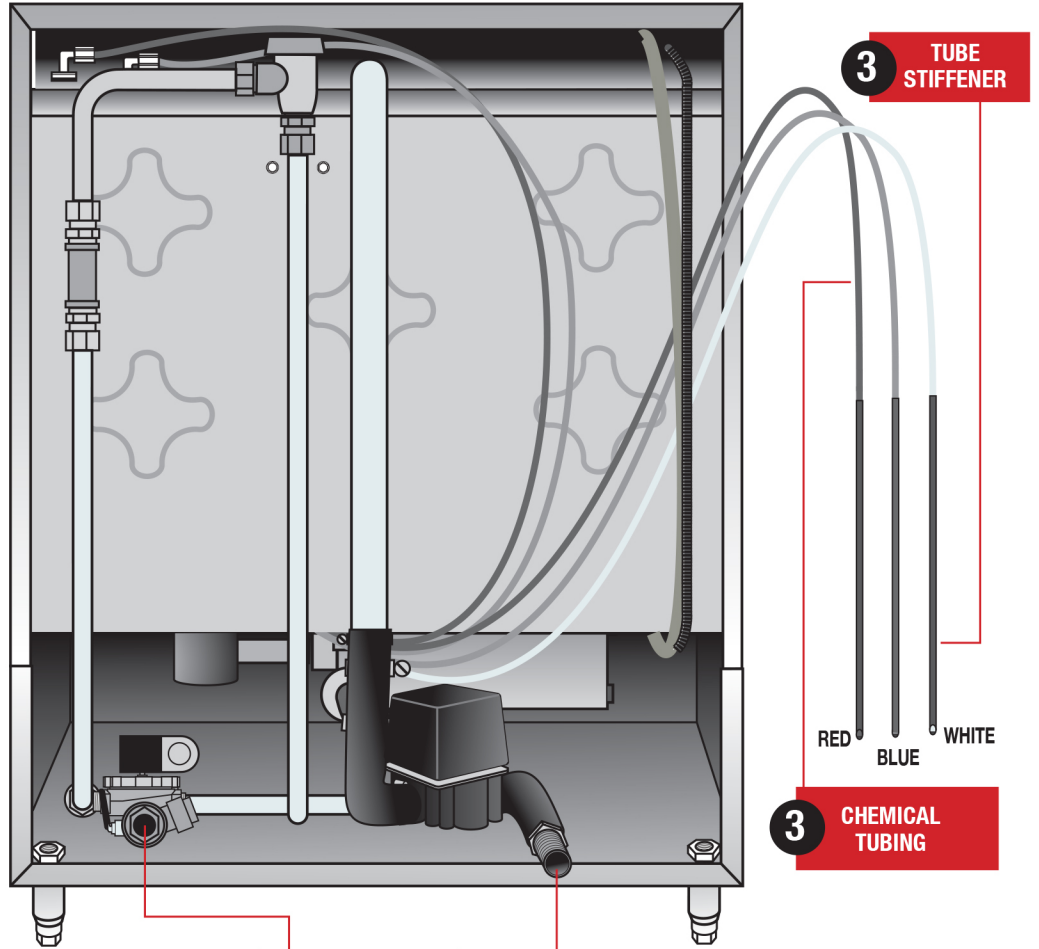

4 LEVELING LEGS

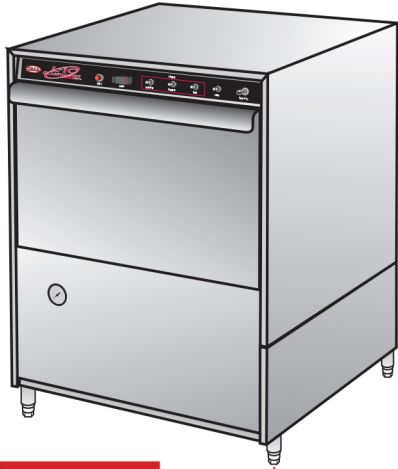
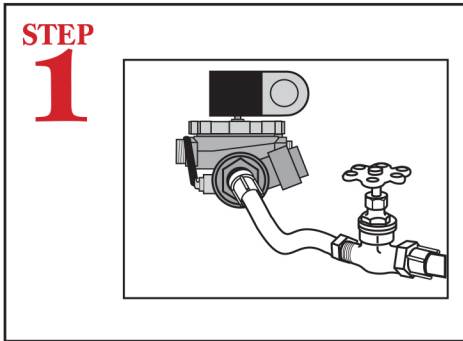

Connect dishmachine to hot water source minimum 120°F required, 140°F temperature recommended.

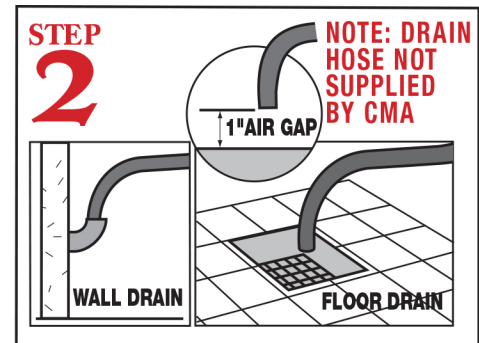

Connect the drain hose to wall or floor drain. The floor drain must have a 1-inch air gap between drain hose and floor drain.

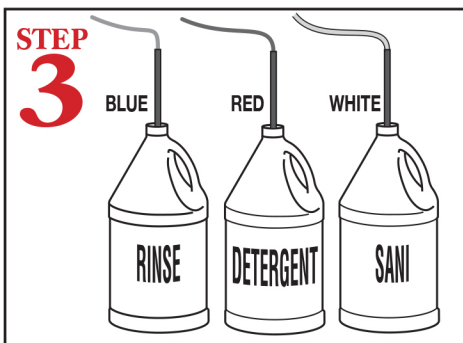

Insert tube stiffener with chemical tubing into each corresponding chemical dispenser.

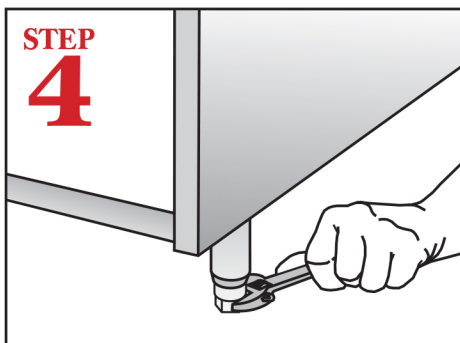

Level dishmachine by adjusting leveling legs. Dishmachine must be level, front and back, to ensure proper performance.

Model L-1C Quick Setup Instructions



WARNING: Electrical and plumbing connections need to be made by a licensed service person and comply with all Federal, State and Local Health, Electrical, Plumbing and Safety codes.

NOTE: WATER AND CHEMICALS TO THIS DISHWASHER MUST BEPROGRAMMED BY A QUALIFIED CHEMICAL SPECIALIST.

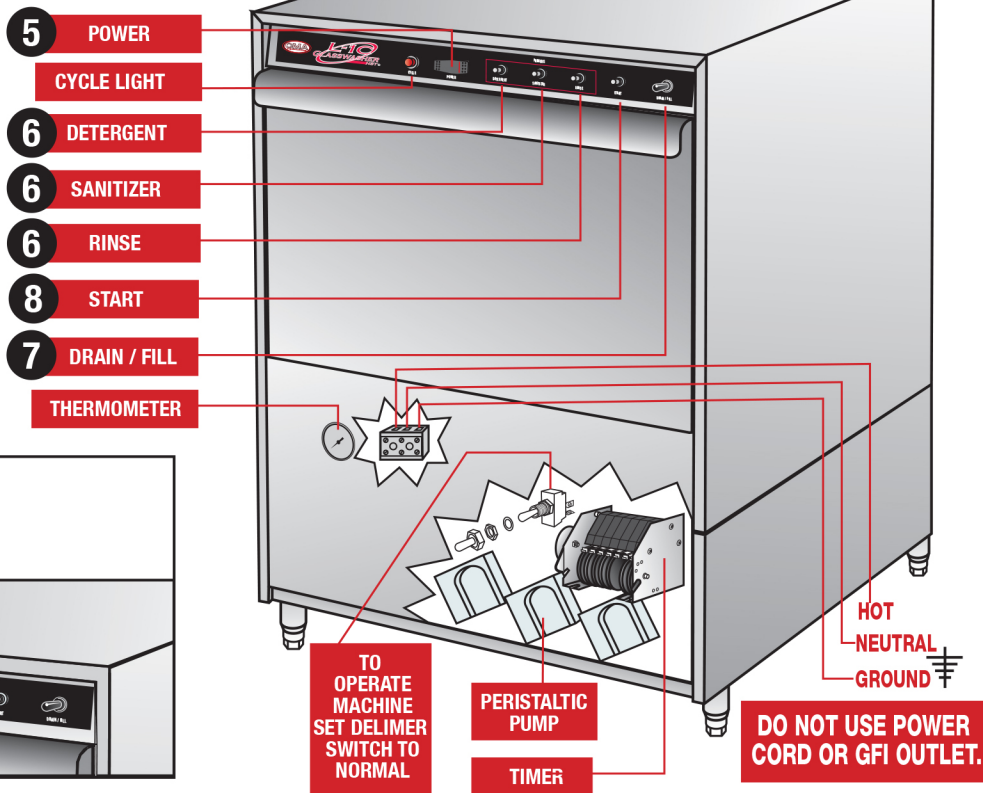

STEP 5

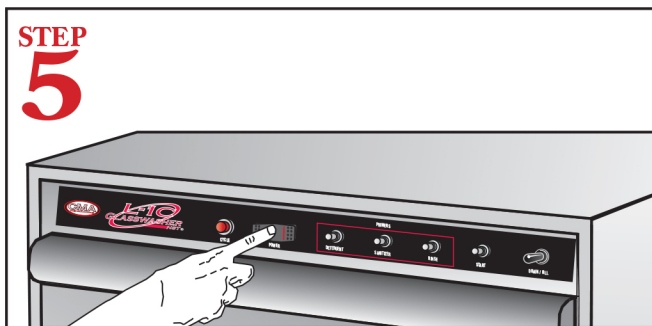

Push power switch to "ON" power.

STEP 6

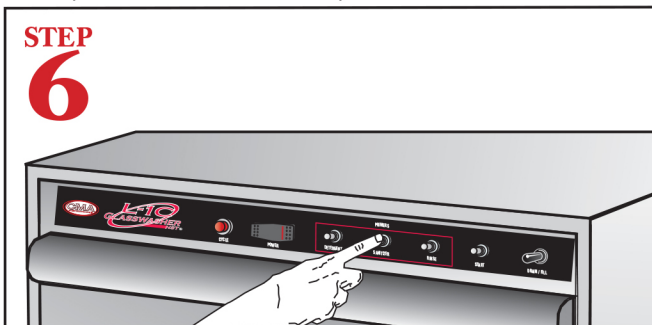

Press and Hold down "SANI", "DETERGENT" and "RINSE" switches to prime chemicals. This step must be repeated each time chemical containers are changed.

STEP 8

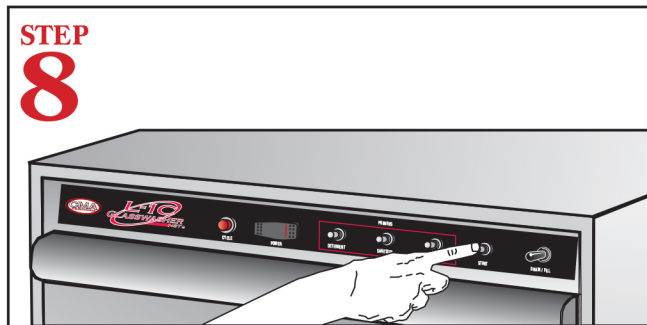

Close the door, then press start switch.

STEP 7

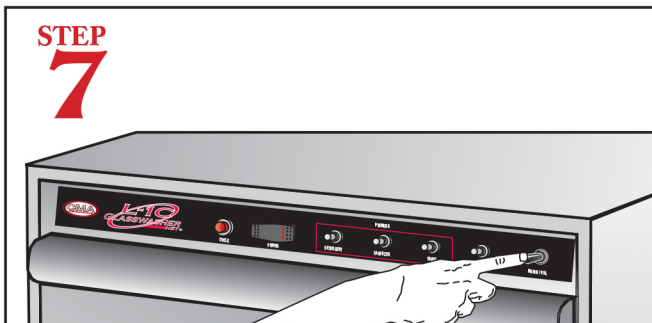

Hold down "FILL" Switch for approximately 10 - 15 seconds to allow water to flow into the dishwasher. Water should reach "FILL LINE" which is located inside at the back of the wash tank. **NOTE:** The 4th cam of timer assembly has to be adjusted to maintain the same water level during the cycle.

